

JUMP 101K - 100l (32cm)  
- NESKLOPNÉ

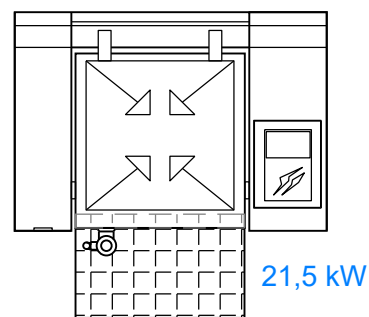

JUMP 151K - 100l (32cm)  
- NESKLOPNÉ

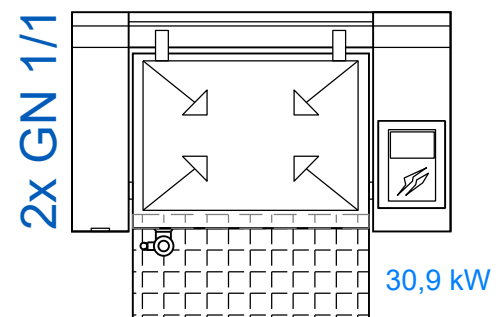

JUMP 201K - 100l (32cm)  
- NESKLOPNÉ

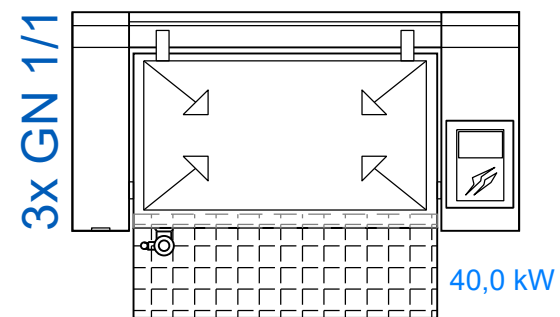

JUMP 181M - 180l

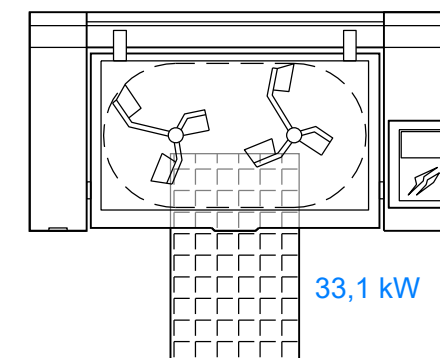

JUMP 101 - 100l (28cm)  
JUMP 101P - 100l - tlak  
JUMP 101F - 75l - nízká (22cm)

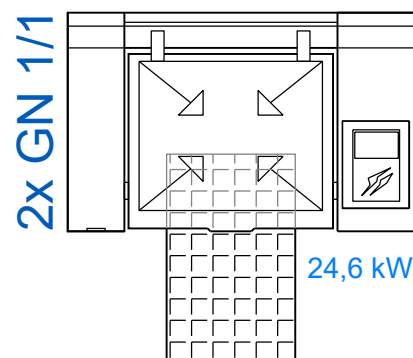

JUMP 151 - 150l (28cm)  
JUMP 151P - 150l - tlak  
JUMP 151F - 110l - nízká (22cm)

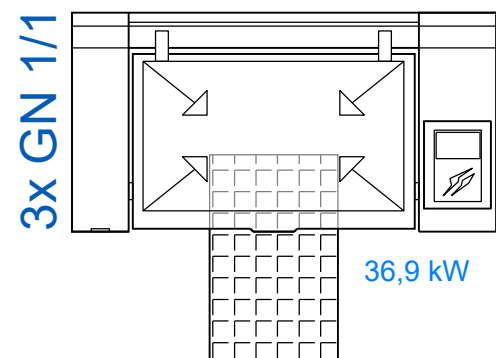

JUMP 251 - 250l (34cm)  
JUMP 201 - 200l (28cm)  
JUMP 201F - 150l - nízká (22cm)

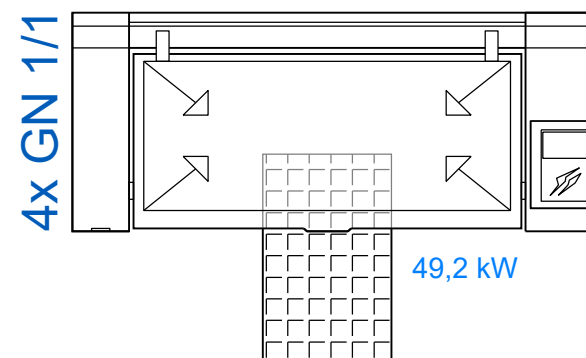

MANIPULAČNÍ ELEKTRICKÝ VOZÍK

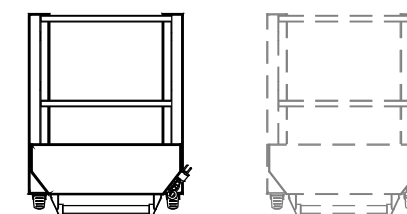

OLEJOVÝ VOZÍK

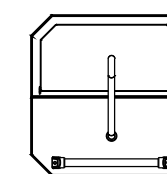

MKH 101DS - 2x 29l - stolní

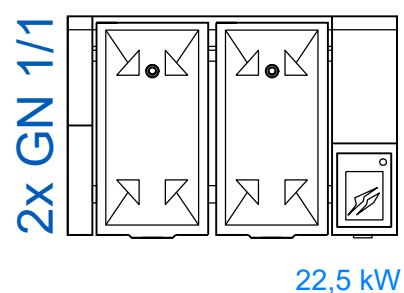

JUMP 101DM - 2x 49l

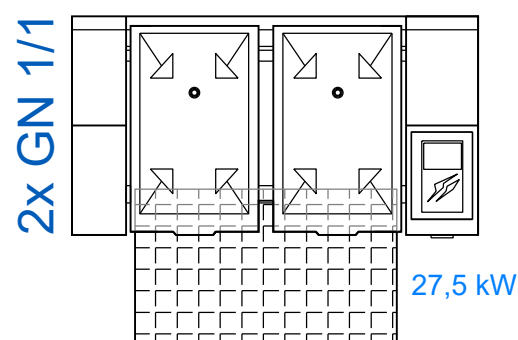

JUMP 101DL - 2x 79l

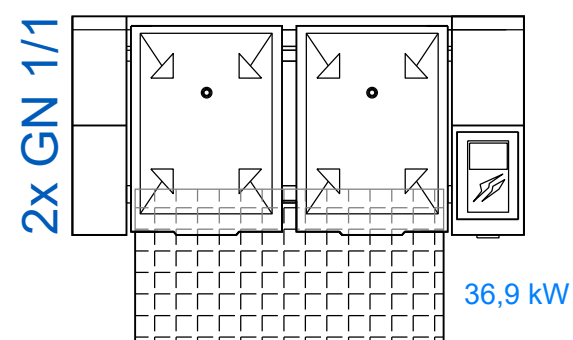

MANIPULAČNÍ VOZÍK NA  
VARNÉ A FRITOVACÍ KOŠE

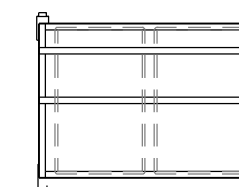

HOLD (až 3x 4 GN1/1)

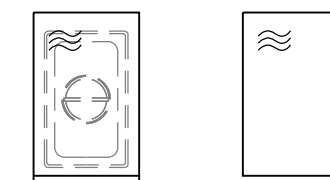

přídavný modul  
základní modul

# ELEKTRICKÁ MULTIFUNKČNÍ ZAŘÍZENÍ - PŘEHLED IKON

JIPA International s.r.o.  
Belnická 603  
252 42 Jesenice u Prahy  
e-mail: [info@jipainternational.cz](mailto:info@jipainternational.cz)  
<http://www.jipainternational.cz>

